



**ZUMTOBEL**

## **CIELOS**

**Modular lighting system**

The essence of wide-area lighting.





**Design** Billings Jackson Design | London

“The lighting effect was meant to resemble a luminous ceiling. We wanted to create something that we could use in a straightforward manner in our own office, and something easy to maintain – this aspect was very important to us. We could see possible applications in shops, reception areas, at hairstylists, in doctors’ surgeries, restaurants, clubs .... indeed everywhere.”

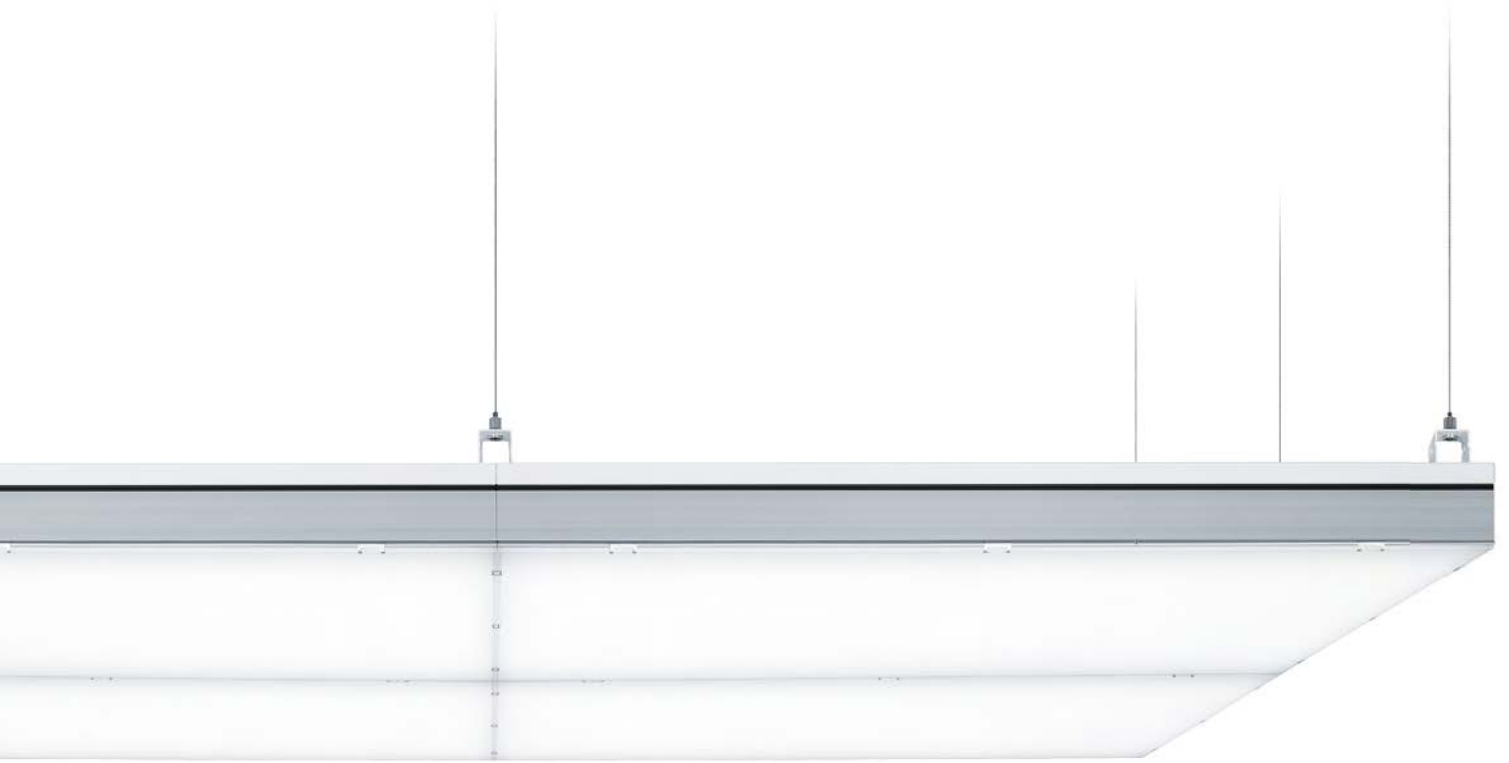

# CIELOS

Modular light



**The essence of wide-area lighting** The modular luminaire turns diffuse surface lighting into a variable, malleable design element for ceilings, walls and objects. CIELOS is no custom-made item, and yet it's tailored to your respective needs. Easy to assemble and to install, with easy-to-maintain surfaces and also very interesting for smaller rooms. Even one single luminous module is able to create an emotional atmosphere, multiplying with each additional module. The diffuser made of high-quality satin-frosted white glass enhances the exclusive appearance of elegant entrance halls, conference rooms and exhibition areas.



# CIELOS

Versatility squared



† CIELOS pendant

The CIELOS luminaire stays in control of the situation in any position. All versions can be used as a solo performer or as part of a luminaire cluster. The fact that fixing and installation are completed in just a few simple steps is a feature that appeals to the practically-minded. There are surface mounting and pendant options for ceilings. CIELOS can be fixed directly onto walls as a vertical design feature.



↑ CIELOS surface-mounted on ceiling

CIELOS wall-mounted →



**Suspended using steel cord**  
Extra-slender and inconspicuous





**CIELOS cord suspension** The extra-slender cord suspension assembly is intended for luminous ceilings comprising up to eight luminaires. The steel cords and their securely fixed metal brackets fulfil two functions: they ensure secure retention of the luminaire while also joining the modules together, eliminating the need for any other connectors. The luminaire modules can therefore be mounted and adjusted quickly. The cord suspension assembly requires minimum space of 90 mm. Thus, a suspended 80 mm CIELOS luminaire takes up only 170 mm of the overall room height.

**Suspended using trunking**

Strong and stable



**CIELOS on ZX2 trunking** This highly robust trunking provides the requisite stability and safety for luminous ceilings consisting of nine or more CIELOS modules and makes full use of its tried-and-tested installation benefits. Suspension and adjustment are very straightforward allowing great craftsmanship without being timeconsuming. The trunking requires a height of just 230 mm. In total, 310 mm must be calculated for a CIELOS luminous ceiling installed on a trunking unit.

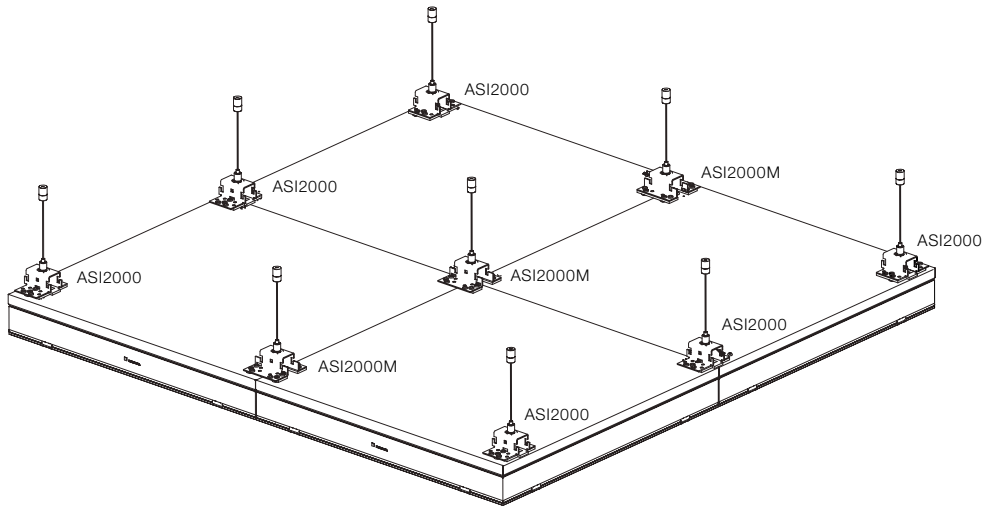

**Ordering example**

For a luminaire panel comprising 2 x 2 CIELOS

4 CIELOS Q600 luminaires	25 W LED	42 181 922
4 through-wiring kits	Q600 through-wiring kit 7 x 1.5 mm <sup>2</sup>	22 161 557
6 cord suspension kits (edge)	ASI2000	22 161 941
3 cord suspension kits (centre)	ASI2000M	22 161 940

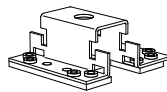

**ASI2000M**  
Connector for  
centre mounting

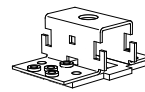

**ASI2000**  
Connector for  
edge mounting

Design tip for **cord suspension**

Cord suspension is recommended if there are eight or fewer luminaires. Perfectly positioned matching metal brackets simplify suspension and precise alignment of individual modules of a luminous ceiling. Cord suspension assembly ASI2000M connects the luminaires located in the centre of the luminaire panel; cord suspension assembly ASI2000 connects the luminaires by their front and rear edges.

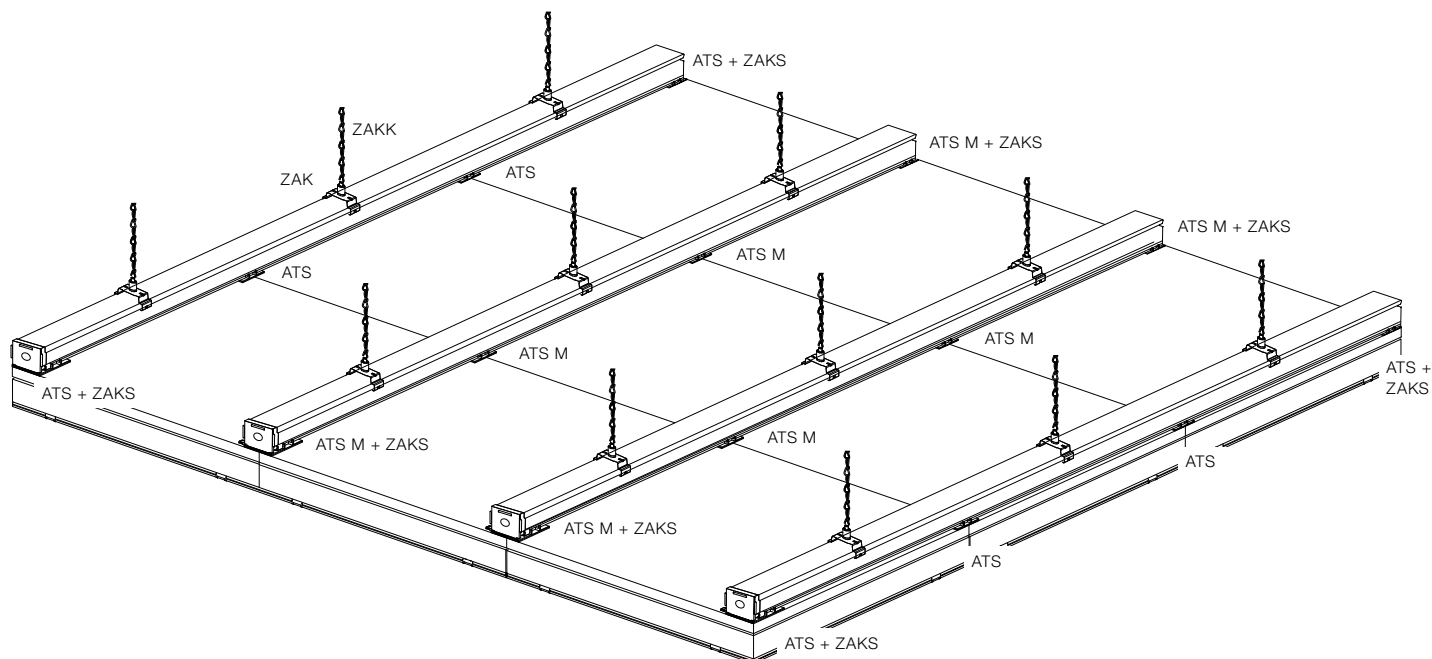

#### Ordering example

For a luminaire panel comprising 3 x 3 CIELOS

9 CIELOS Q900 luminaires	32 W LED	42 181 924
8 through-wiring units	Through-wiring kit Q900 7 x 1.5 mm <sup>2</sup>	22 161 558
4 trunking units	ZX2 T 3240 WH	22 157 860
8 end caps	ZX2 T-E	22 157 793
8 U-clamp terminals	ZAKS	03 231 208
8 connectors (edge)	ATS	22 161 937
8 connectors (centre)	ATS M	22 161 938
12 chain suspension kits	ZAK	20 350 553
12 knotted link chains (12 m in total)	ZAKK	20 042 906

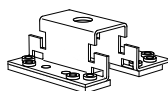

**ATS M**  
Connector for  
centre mounting

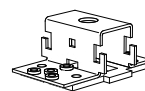

**ATS**  
Connector for  
edge mounting

#### Design tip for **mounting on trunking**

Nine or more CIELOS luminaires need the stability provided by trunking. Easy to assemble and adjust, the ZX2 trunking units can be arranged anywhere in the room. Connection to other ceiling systems is also possible. When doing so, make sure that all CIELOS modules are attached to the strong ZX2 trunking unit. All types of drywall ceilings can be butted up against a CIELOS luminous ceiling, but ceiling and luminous field cannot be mechanically joined.

[...] Shared properties CIELOS

- Glass cover made of single-pane frosted safety glass (ESG)
- Frameless optic retained by means of discrete stainless-steel springs
- Housing made of sheet steel, painted white
- Easy maintenance: even those elements enclosed on all sides by other modules can be opened individually
- Luminaire pre-wired using halogen-free leads

**Installation CIELOS ceiling-mounted light**

**CIELOS 1C 600 T16/LED**

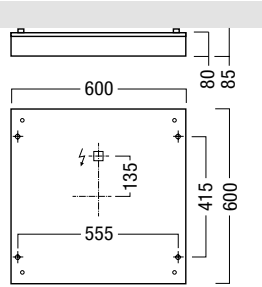

**CIELOS 1C 800 LED**

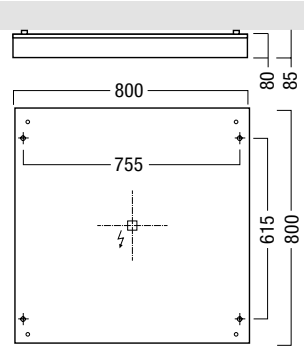

**CIELOS 1C 900 T16**

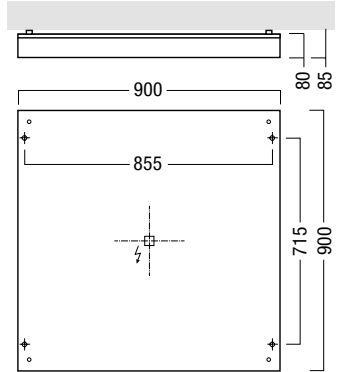

**Installed on ceiling or wall**

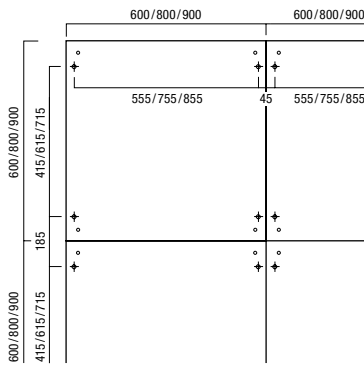

**Cord suspension (max. 2x2 module)**

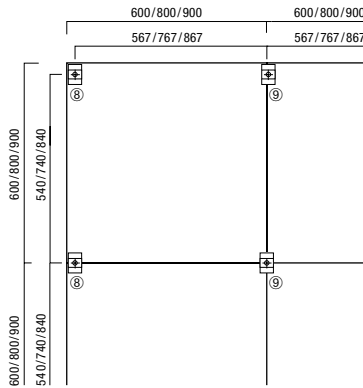

**Trunking installation**

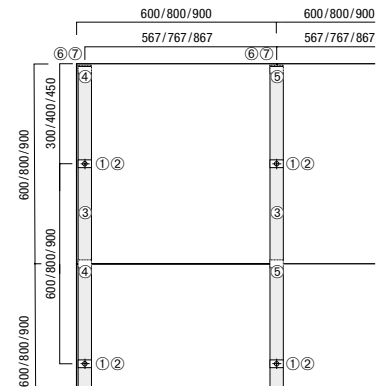

**Accessories required depending on installation type:**

*Cord suspension*

- Ⓢ cord suspension (ASI2000): 22 161 941
- Ⓣ cord suspension (ASI2000M): 22 161 940

*For trunking installation*

- ① ZAK chain suspension: 20 350 553
- ② ZAKK knotted link chain: 20 042 906
- ③ ZX2 T 3240 WH trunking: 22 157 860
- ④ ATS connector: 22 161 937
- ⑤ ATSM connector: 22 161 938
- ⑥ ZAKS U-clamp terminal: 03 231 208
- ⑦ ZX2 T-E Paar end cap: 22 157 793

CIELOS Monocolor (1C)



- [...]
  - Modular T16 luminaire for creating dynamic light surfaces on the ceiling or wall
  - High quality appearance with frosted white glass cover and natural anodised aluminium
  - Diffuse light distribution and visible luminance for pleasant, glare-free light
  - Double-diffusion chamber optic for extremely low-profile 80 mm design
  - For monochromatic lighting design (1C)
  - DALI control possible

	L/W/H	kg	Order no.	Order no.
<b>Modular lighting tile, one colour 1C</b>			<i>electronic</i>	<i>dimnable Dali</i>
4/14 WT16	600/600/80	11,4	42 177 122	42 177 123
6/21 WT16	900/900/80	15,1	42 177 112	42 177 113

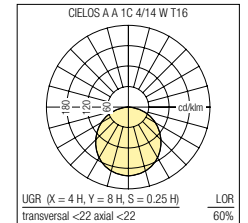
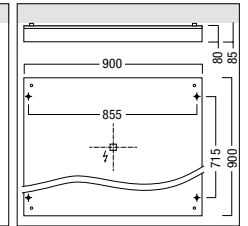
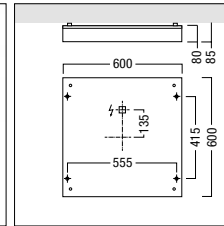

CIELOS Monocolor LED (1C)

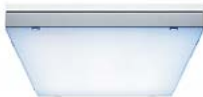

- [...]
  - Modular luminaire for designing illuminated areas on ceilings or walls in prestigious areas
  - High quality appearance with frosted white glass cover and natural anodised aluminium
  - Diffuse light distribution and visible luminance for pleasant, glare-free light
  - Extremely low 80 mm construction
  - Aluminium chamber optic in natural anodised finish
  - DALI control possible

	L/W/H	kg	Order no.
<b>Modular lighting tile, one colour 1C</b>			
25 W LED 830 Q600 <i>eco+</i>	600/600/80	12,0	42 181 923
25 W LED 840 Q600 <i>eco+</i>	600/600/80	12,0	42 181 922
33 W LED 830 Q800	800/800/80	19,0	42 182 105
33 W LED 840 Q800	800/800/80	19,0	42 182 104

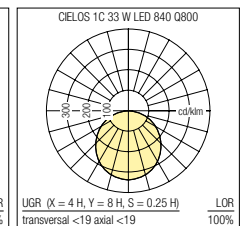
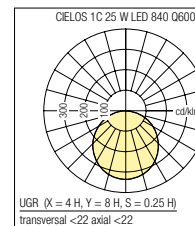

CIELOS accessories

- Through-wiring for simple and space-saving wiring between luminaires
- Accessories for cord installation
- Accessories for track mounting

	L/W/H	kg	Order no.
<b>Cord suspension</b>			
ASI2000	2/2/2000		22 161 941
ASI2000M	2/2/2000	0,1	22 161 940
<b>Installed on trunking</b>			
ATS Link		0,2	22 161 937
ATS M Link		0,2	22 161 938
ZAK Chain suspension assembly white			20 350 553
ZAKK Knotted chain by the metre (nickel) galvanised		0,1	20 042 906
ZAKS Cage clamp terminal, white			03 231 208
ZX2 T 3240 WH white	3240/60/52	3,0	22 157 860
ZX2 T-E	1/63/56		22 157 793
ZX2 T-V straight connector		0,6	22 157 756
<b>Video driver</b>			
CCS Video drive		0,9	22 162 066
<b>Through-wiring</b>			
DV-Set Q600 7x1,5mm <sup>2</sup>		0,2	22 161 557
DV-Set Q900 7x1,5mm <sup>2</sup>		0,3	22 161 558
<b>Installation accessories</b>			
Rubber seal, 1 m (for wall and surface-mounting)			22 157 838
Suction cup			20 935 455





zumtobel.com/office

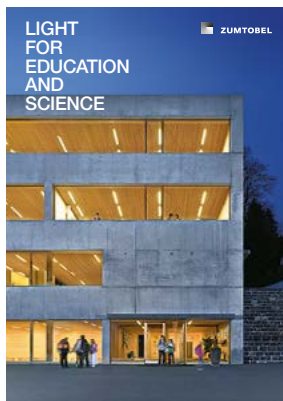

zumtobel.com/education



zumtobel.com/shop



zumtobel.com/hotel



zumtobel.com/culture



zumtobel.com/healthcare



zumtobel.com/industry

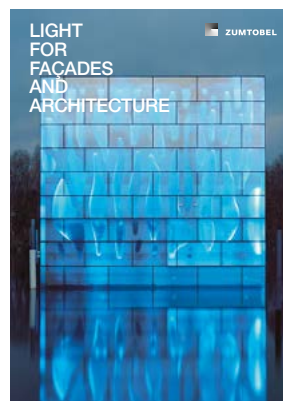

zumtobel.com/facade

**Zumtobel is the internationally leading supplier of integral lighting solutions for professional interior and exterior lighting applications.**

- Offices and Communication
- Education and Science
- Presentation and Retail
- Hotel and Wellness
- Art and Culture
- Health and Care
- Industry and Engineering
- Façades and Architecture

We provide unique customer benefits by integrating technology, design, emotion and energy efficiency. Under the Humanergy Balance concept, we combine the best possible ergonomic lighting quality for an individual's well-being with the responsible use of energy resources. The company's own sales organisations in twenty countries, as well as commercial agencies in fifty other countries, form an international network of experts and design partners providing professional lighting consulting, design assistance and comprehensive services.

**Lighting and sustainability**

In line with our corporate philosophy *"We want to use light to create worlds of experience, make work easier and improve communications and safety while remaining fully aware of our responsibility to the environment"*, Zumtobel offers energy-efficient high-quality products, while at the same time making sure that our production processes based on the considerate use of resources are environmentally compatible.

[zumtobel.com/sustainability](http://zumtobel.com/sustainability)



**Top quality – with a five-year guarantee.**

As a globally leading luminaire manufacturer, Zumtobel provides a five year manufacturer's guarantee on all Zumtobel branded products subject to registration within 90 days from the invoice date and in accordance with the terms of guarantee at [zumtobel.com/guarantee](http://zumtobel.com/guarantee).

Order no. 04 797 792-EN 05/2014 © Zumtobel Lighting GmbH  
 Technical data was correct at time of going to press.

We reserve the right to make technical changes without notice. Please contact your local sales office for further information. For the sake of the environment: Luxo Light is chlorine-free paper from sustainably managed forests and certified sources.







Tracks and spots



Modular lighting systems



Downlights



Recessed luminaires



Surface-mounted and pendant luminaires



Free-standing and wall-mounted luminaires



Continuous-row systems and individual batten luminaires



High-bay luminaires and floodlight reflector systems



Luminaires with extra protection

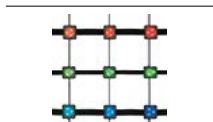

Façade, media and outdoor luminaires



Lighting management systems



Emergency lighting



Medical supply systems

### United Kingdom

Zumtobel Lighting Ltd.  
Chiltern Park  
Chiltern Hill, Chalfont St. Peter  
Buckinghamshire SL9 9FG  
T +44/(0)1753 482 650  
F +44/(0)1753 480 350  
uksales@zumtobel.com  
zumtobel.co.uk

### USA and Canada

Zumtobel Lighting Inc.  
3300 Route 9W  
Highland, NY 12528  
T +1/(0)845/691 6262  
F +1/(0)845/691 6289  
zli.us@zumtobel.com  
zumtobel.us

### Australia and New Zealand

Zumtobel Lighting Pty Ltd  
333 Pacific Highway  
North Sydney, NSW 2060  
T +61/(2)8913 5000  
F +61/(2)8913 5001  
info@zumtobel.com.au  
zumtobel.com.au

### China

Zumtobel Lighting China  
Shanghai office  
Room 101,  
No 192 YIHONG Technology Park  
Tianlin Road, Xuhui District  
Shanghai City, 200233, P.R. China  
T +86/(21) 6375 6262  
F +86/(21) 6375 6285  
sales.cn@zumtobel.com  
zumtobel.cn

### Hong Kong

Zumtobel Lighting Hong Kong  
Unit 4319-20, Level 43,  
Tower 1, Metroplaza,  
223 Hing Fong Road,  
Kwai Fong, N.T.  
T +852/(0)2503 0466  
F +852/(0)2503 0177  
info.hk@zumtobel.com

### India

Zumtobel Lighting GmbH  
1522, Devika Tower,  
6, Nehru Place,  
110019 New Delhi  
T +91/11 4601 2782  
info.in@zumtobel.com

### Singapore

Zumtobel Lighting Singapore  
158 Kallang Way # 06-01/02  
Singapore 349245  
T +65 6844 5800  
F +65 6745 7707  
info.sg@zumtobel.com

### United Arab Emirates

Zumtobel Lighting GmbH  
4B Street, Al Quoz Industrial Area  
Dubai, United Arab Emirates  
T +971/4 340 4646  
F +971/4 299 3531  
info@zumtobeluae.ae  
zumtobel.ae

### Romania

Zumtobel Lighting Romania SRL  
Radu Greceanu Street, no. 2,  
Ground Floor, sector 1  
012233 Bucharest  
T +40 731 32 1200  
welcome.ro@zumtobel.com  
zumtobel.com

### Hungary

Zumtobel Lighting Kft  
Váci út 49  
1134 Budapest  
T +36/(1) 3500 828  
F +36/(1) 3500 829  
welcome@zumtobel.hu  
zumtobel.hu

### Croatia, Bosnia and Herzegovina

Zumtobel Licht d.o.o.  
Radnička cesta 80 – Zagrebtower  
10000 Zagreb  
T +385/(1) 64 04 080  
F +385/(1) 64 04 090  
welcome@zumtobel.hr  
welcome.ba@zumtobel.com

### Serbia

Zumtobel Licht d.o.o.  
Karadjordjeva 2-4  
Beton Hala  
11000 Belgrade  
T +381/(0)11 65 57 657  
F +381/(0)11 65 57 658  
welcome@zumtobel.rs

### Czech Republic

Zumtobel Lighting s.r.o.  
Jankovcova 2  
Praha 7  
17000 Praha  
T +420/(2) 66 782 200  
F +420/(2) 66 782 201  
welcome@zumtobel.cz  
zumtobel.cz

### Slovak Republic

Zumtobel Lighting s.r.o.  
Vlčie Hrdlo 1,  
824 12 Bratislava  
welcome@zumtobel.sk  
zumtobel.sk

### Poland

Zumtobel Licht GmbH Sp.z.o.o.  
Platinum III  
ul. Wołoska 9a  
02-583 Warszawa  
T +48/(22) 856 74 31  
F +48/(22) 856 74 32  
welcome@zumtobel.pl  
zumtobel.pl

### Slovenia

Zumtobel Licht d.o.o.  
Štukljeva cesta 46  
1000 Ljubljana  
T +386/(1) 5609 820  
F +386/(1) 5609 866  
welcome@zumtobel.si  
zumtobel.si

### Russia

Zumtobel Lighting GmbH  
Official Representative Office  
Skakovaya Str. 17  
Bld. No 1, Office 1104  
125040 Moscow  
T +7/(495) 945 36 33  
F +7/(495) 945 16 94  
info-russia@zumtobel.com  
zumtobel.ru

### Norway

Zumtobel Belysning  
Hoffsveien 4  
Postboks 1025 Hoff  
0218 Oslo  
T +47 22 06 50 50  
firmapost@zumtobel.com  
zumtobel.no

### Sweden

Zumtobel Belysning  
Birger Jarlsgatan 57  
11356 Stockholm  
T +46 8 26 26 50  
info.se@zumtobel.com  
zumtobel.se

### Denmark

Zumtobel Belysning  
Store Kongensgade 118  
1264 København  
T +45 35 43 70 00  
info.dk@zumtobel.com  
zumtobel.dk

### Headquarters

Zumtobel Lighting GmbH  
Schweizer Strasse 30  
Postfach 72  
6851 Dornbirn, AUSTRIA  
T +43/(0)5272/390-0  
info@zumtobel.info

Zumtobel Licht GmbH  
Grevnemarschstrasse 74-78  
32657 Lemgo, GERMANY  
T +49/(0)5261 212-0  
F +49/(0)5261 212-7777  
info@zumtobel.de

### zumtobel.com



**ZUMTOBEL**

## **CIELOS**

### **Modular lighting system**

The essence of wide-area lighting.

